

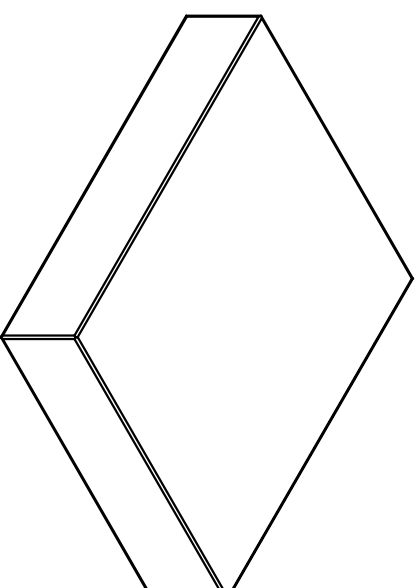

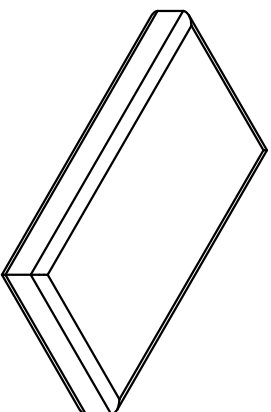

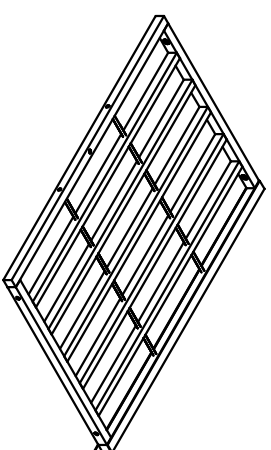

ASSEMBLY INSTRUCTION

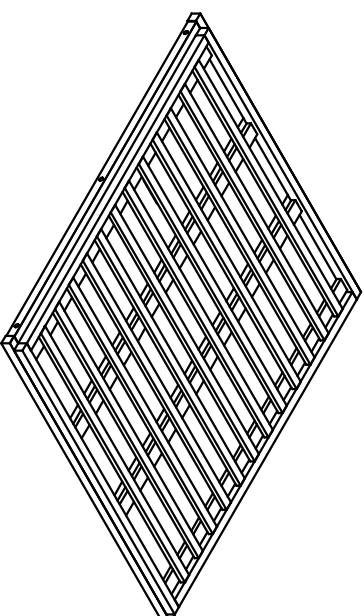
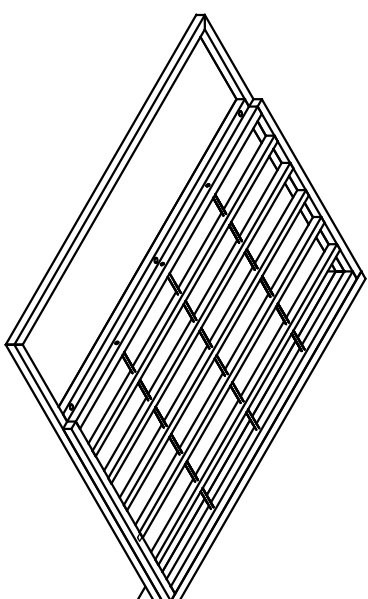
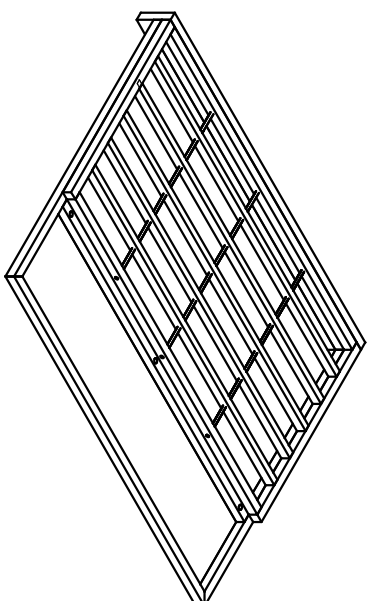
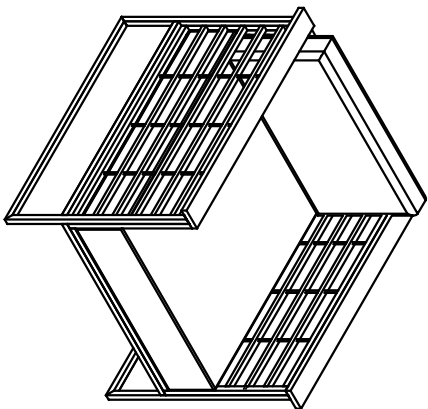

REQUIRED TOOL



No.		Qty.
A	 6x35x13mm	6
B	 Ø6/16x1mm	6
C	 6x30x13mm	5
D	 4x15x8mm	2
E	 Ø5/12x1mm	2
F	 A4	2

ASSEMBLY INSTRUCTION

Step 1

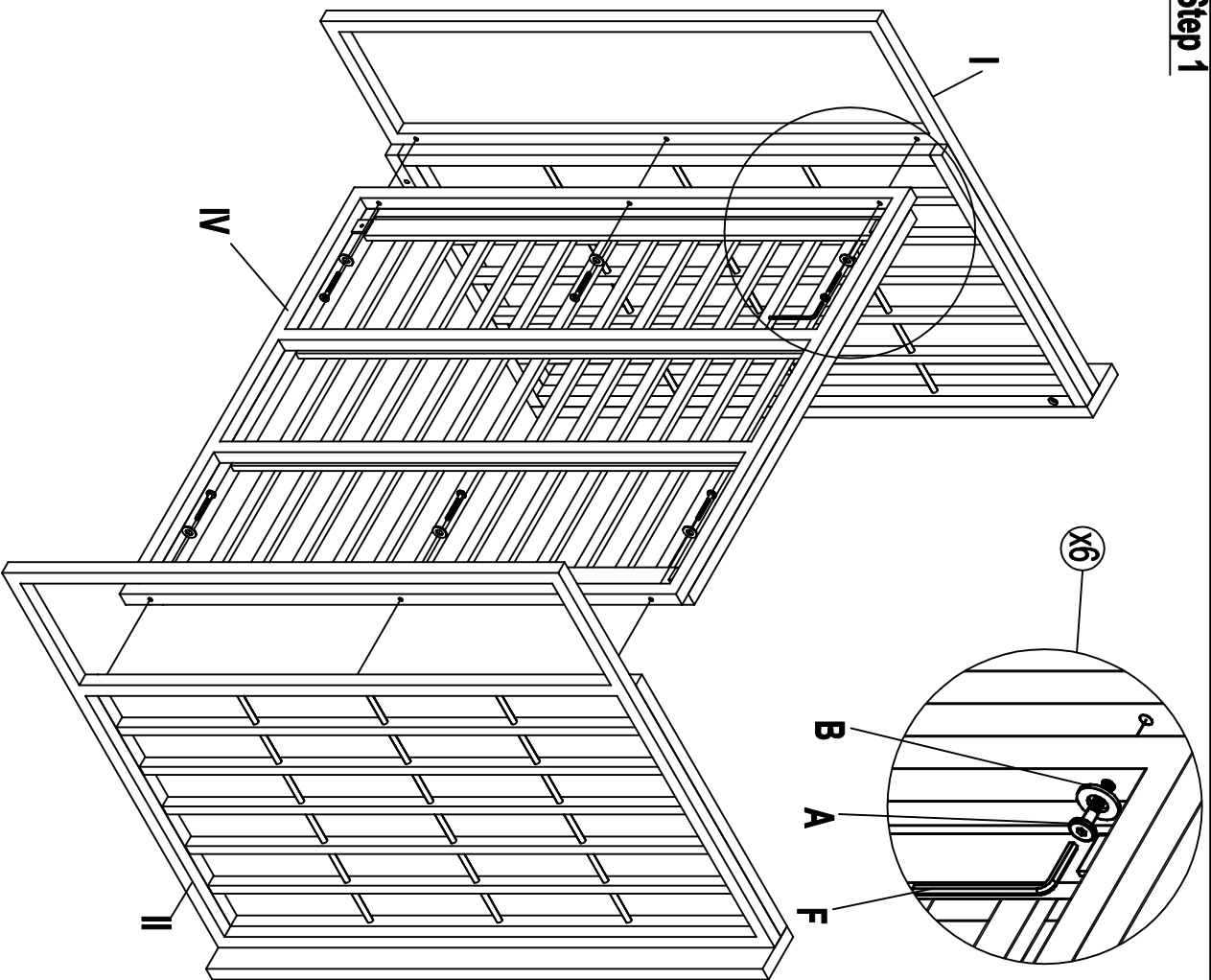

Step 2

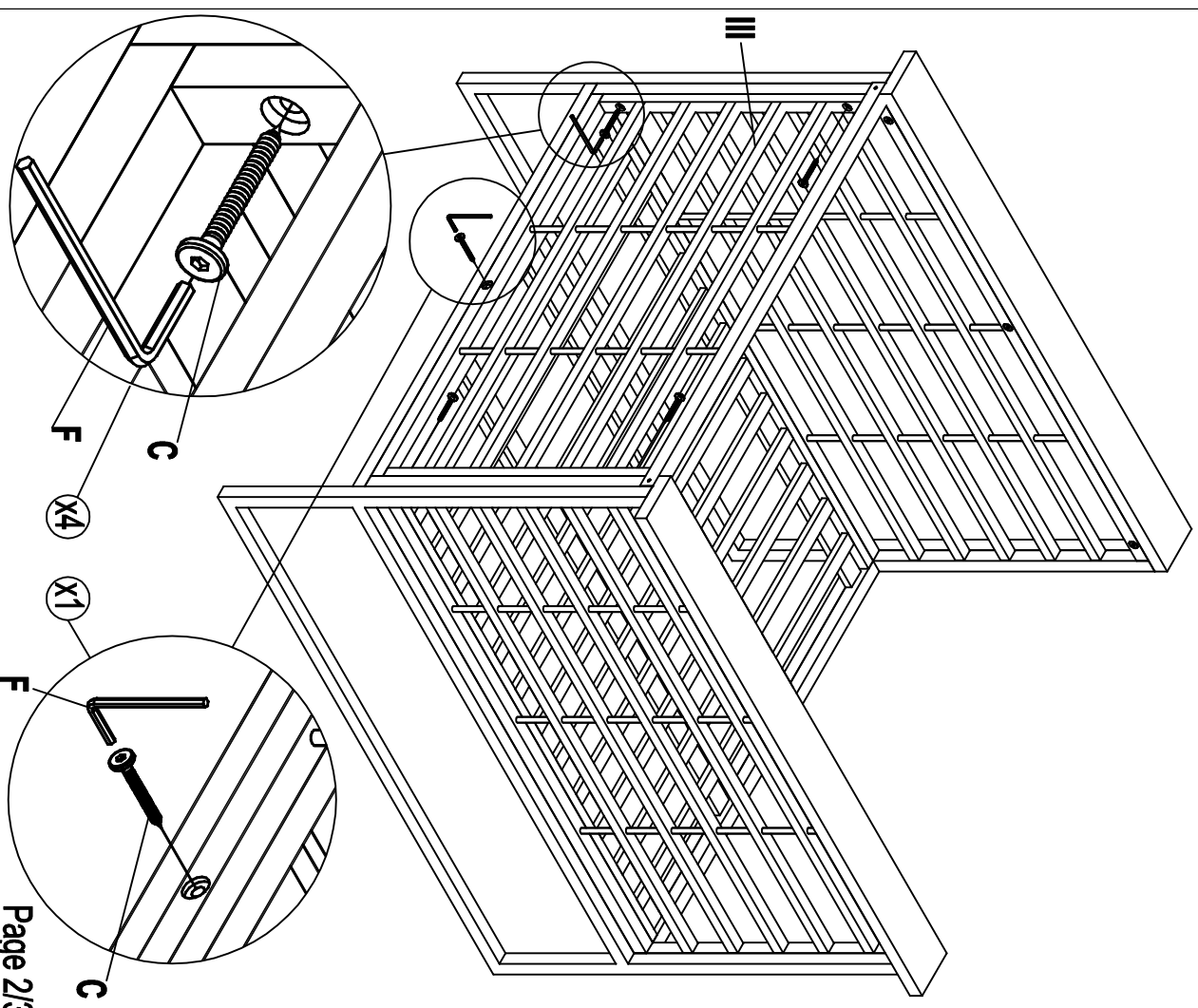

ASSEMBLY INSTRUCTION

Step 3

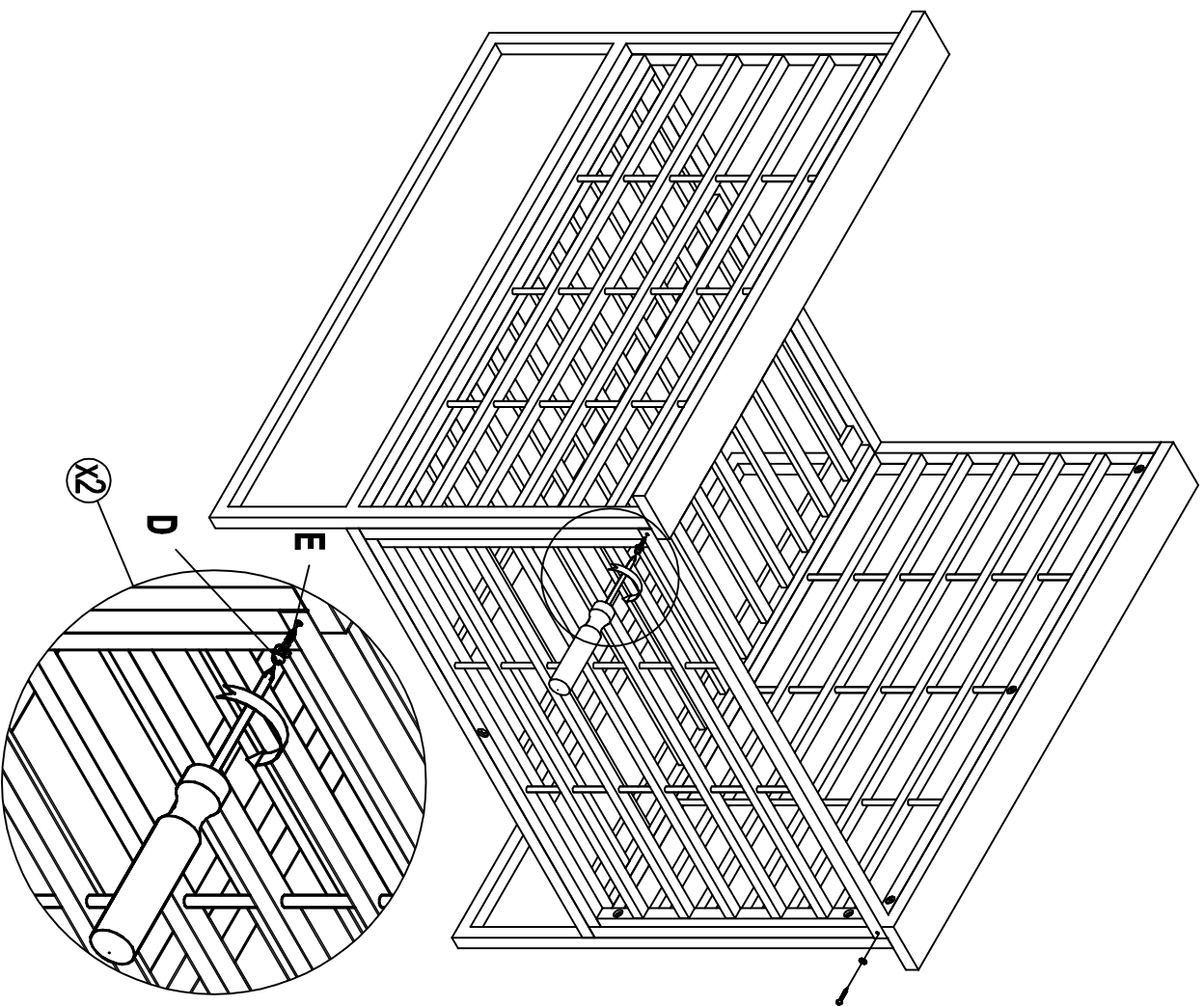

Step 4

