

1411.0075

Line 1411.0075

Ø 75 mm horizontal drain

The water trap can be removed and separated for cleaning

Can be rotated 180 degrees if a rear-facing outlet is required



Specifications

ITEM NUMBER	GTIN NUMBER	WEIGHT INCLUDING PACKAGING
1411.0075	5707692007977	525 g
WEIGHT EXCLUDING PACKAGING	MATERIAL	USAGE
332 g	Plastic (PP)	Line drain
BARRIER	GASKET	CAPACITY
With	EPDM	1.0 l/s
SIDE INLET	CENTER	FITS DRAIN UNIT
Without	48 mm	1001, 1002, 1003, 1004, 1100, 3002, 3004, 5002, 5003

FITTING HEIGHTS - LINE FAUCETS 1001, 1002, 1003, 1004

Ø	Outlet direction	300	600	700	800	900	1000	1200
Ø 75 mm	Horizontal	98 mm		103 mm	104 mm	105 mm	106 mm	108 mm

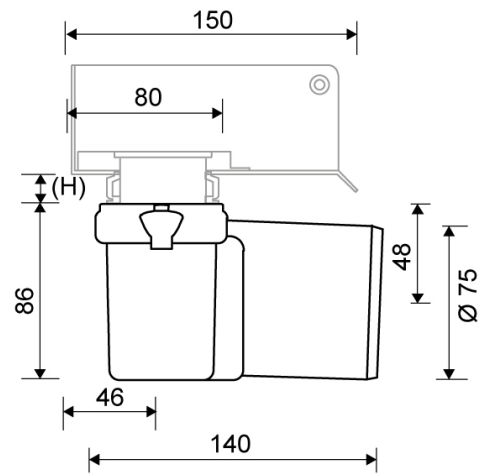
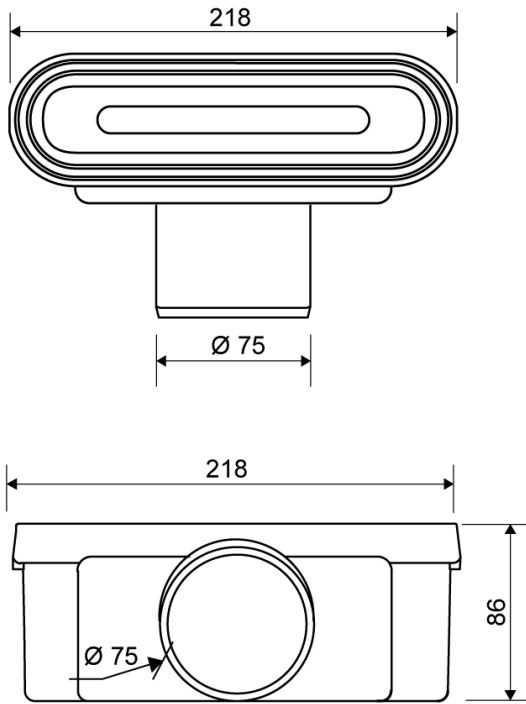

1411.0075

Products